



US007457196B2

(12) **United States Patent**
Acker et al.

(10) **Patent No.:** **US 7,457,196 B2**
(45) **Date of Patent:** **Nov. 25, 2008**

(54) **NETWORKED SONAR OBSERVATION OF
SELECTED SEABED ENVIRONMENTS**

(75) Inventors: **Timothy W. Acker**, Arlington, WA (US);
Assad E. K. Ebrahim, Bellevue, WA
(US); **James J. Dawson**, Edmonds, WA
(US)

(73) Assignee: **Biosonics, Inc.**, Seattle, WA (US)

(*) Notice: Subject to any disclaimer, the term of this
patent is extended or adjusted under 35
U.S.C. 154(b) by 0 days.

(21) Appl. No.: **11/458,011**

(22) Filed: **Jul. 17, 2006**

(65) **Prior Publication Data**

US 2008/0013404 A1 Jan. 17, 2008

(51) **Int. Cl.**
G01S 15/89 (2006.01)

(52) **U.S. Cl.** **367/88**

(58) **Field of Classification Search** 367/7,
367/11, 88, 902, 131, 134

See application file for complete search history.

(56) **References Cited**

U.S. PATENT DOCUMENTS

3,541,499 A * 11/1970 Gosta 367/902
6,850,173 B1 * 2/2005 Steinbrecher 367/131
2006/0013068 A1 * 1/2006 Wilson 367/111
2006/0018197 A1 * 1/2006 Burczynski et al. 367/87
* cited by examiner

Primary Examiner—Dan Pihulic

(74) *Attorney, Agent, or Firm*—Black Lowe & Graham PLLC

(57) **ABSTRACT**

A sonar transducer network for observing a seabed includes a controller. A first transducer assembly includes a first acoustic transducer to convert a first ping to a first electrical signal; and a first transducer processor to receive a first electrical signal from the first acoustic transducer to generate the first transducer data. At least one second transducer assembly is spaced apart from the first transducer assembly. The second transducer assembly includes a second acoustic transducer to convert a second ping to a second electrical signal. The second transducer processor receives the second electrical signal from the second acoustical transducer to generate second transducer data. A network bus communicates first transducer data and second transducer data with the controller.

24 Claims, 8 Drawing Sheets

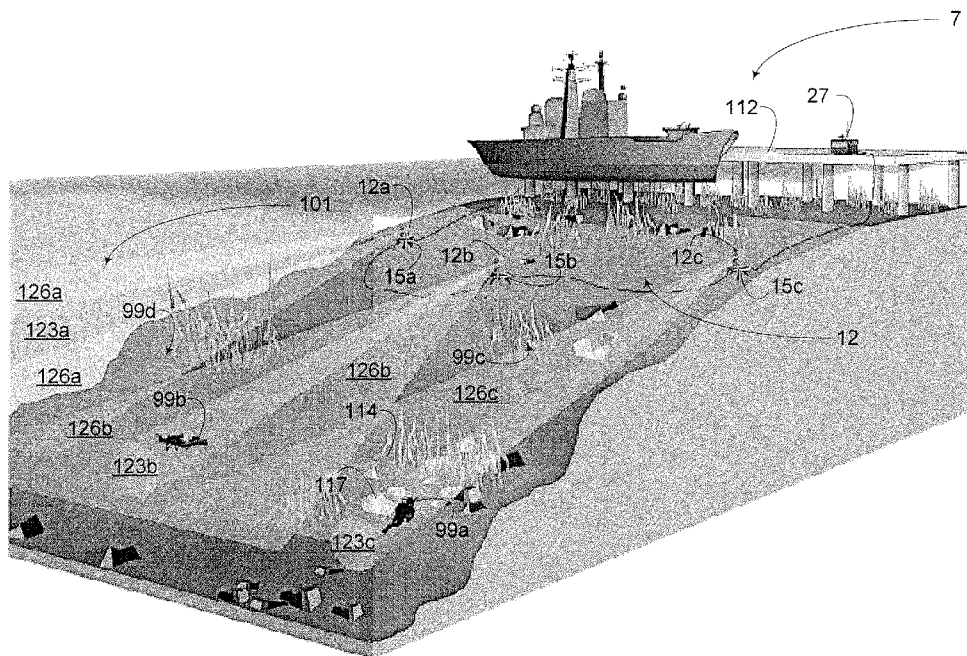

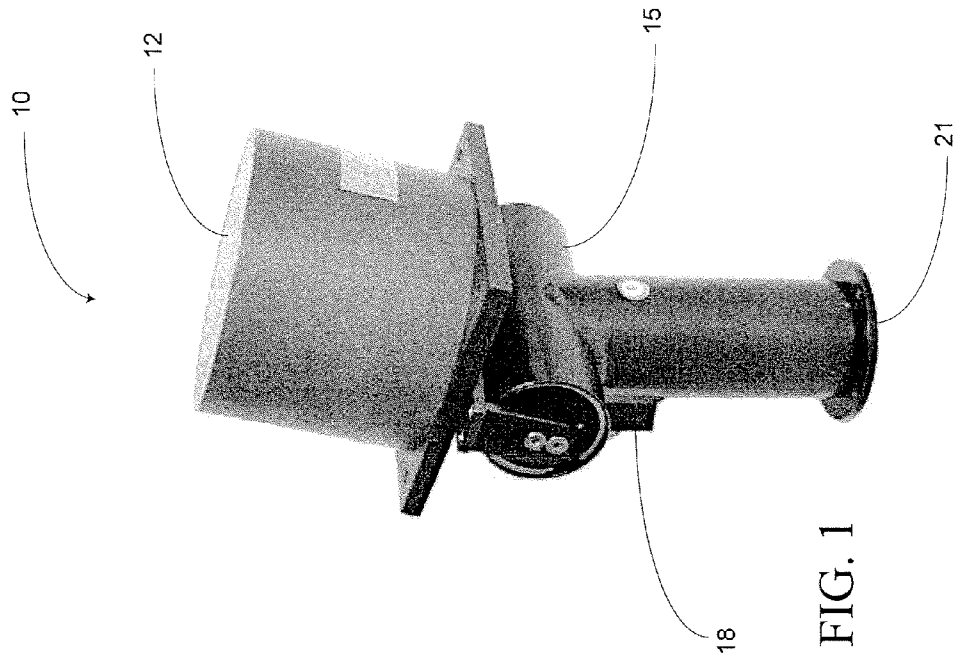

FIG. 1

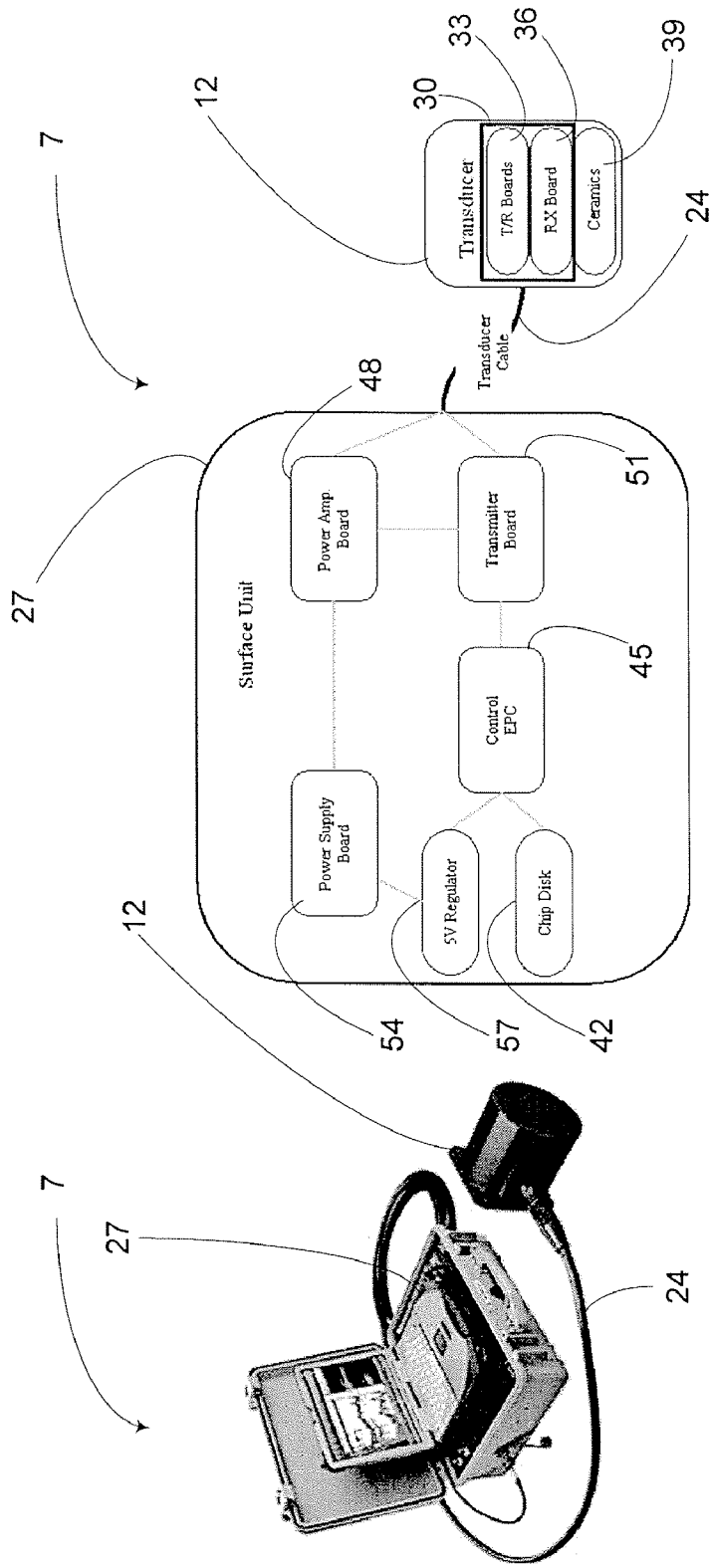

FIG. 2b

FIG. 2a

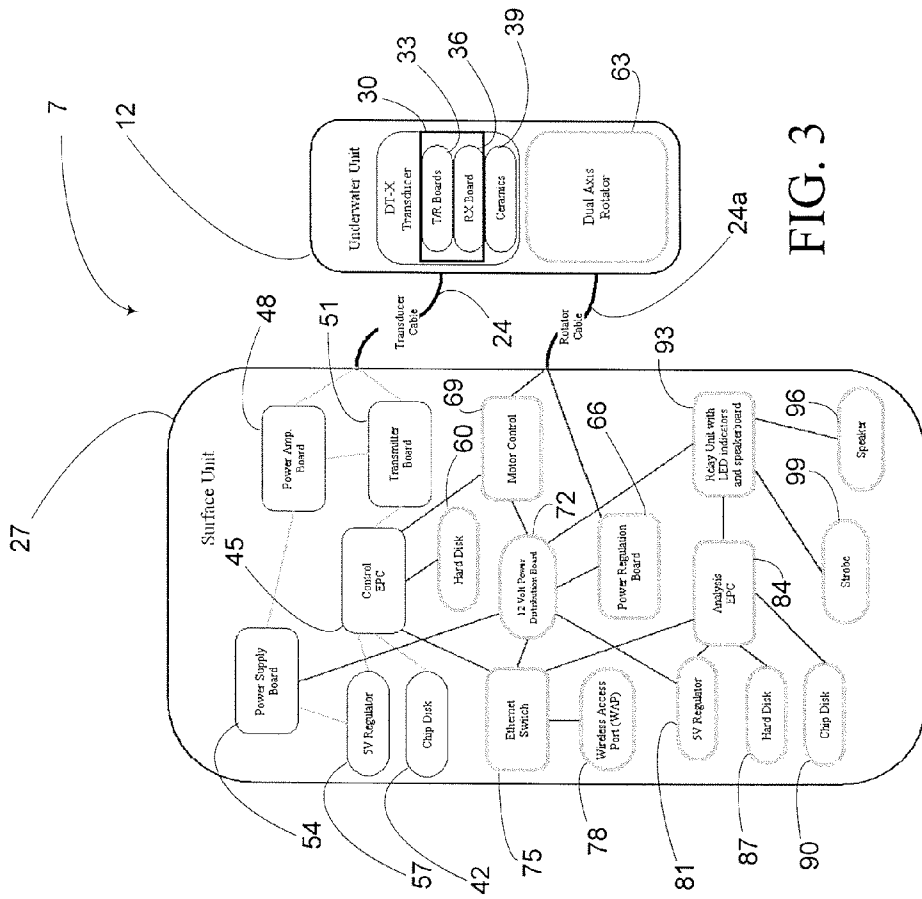

FIG. 3

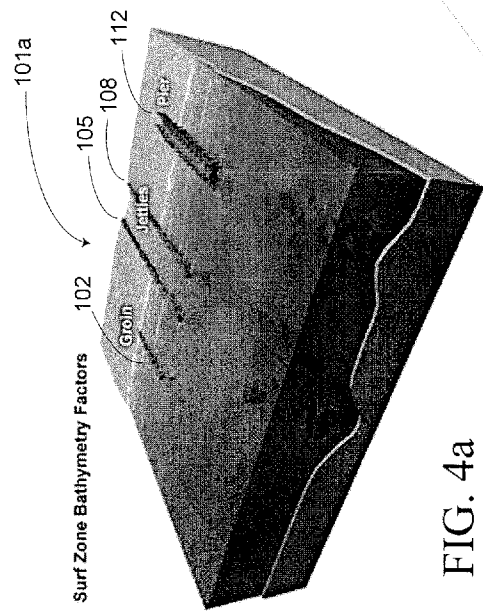

FIG. 4a

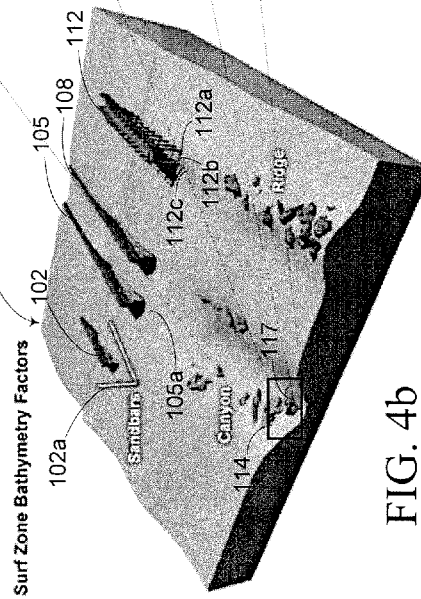

FIG. 4b

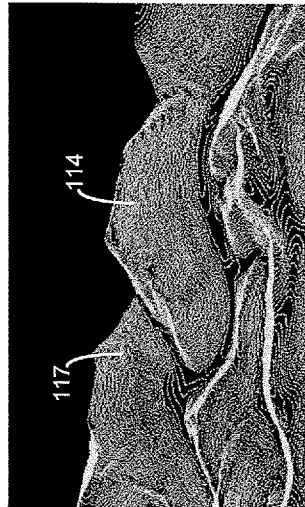

FIG. 4c

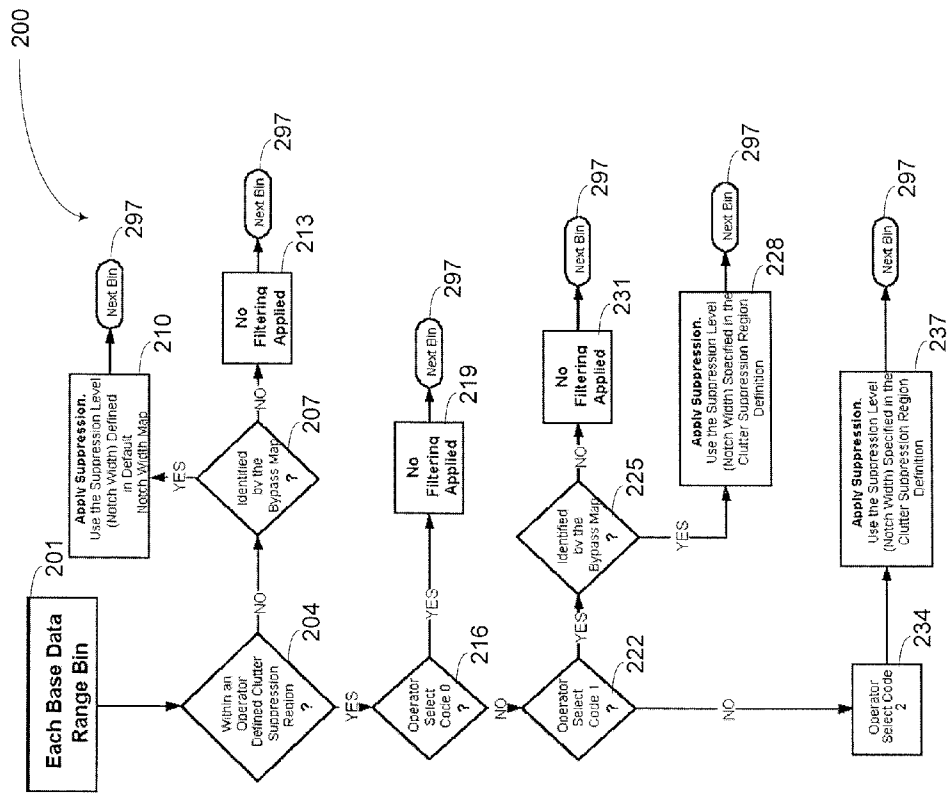

FIG. 5

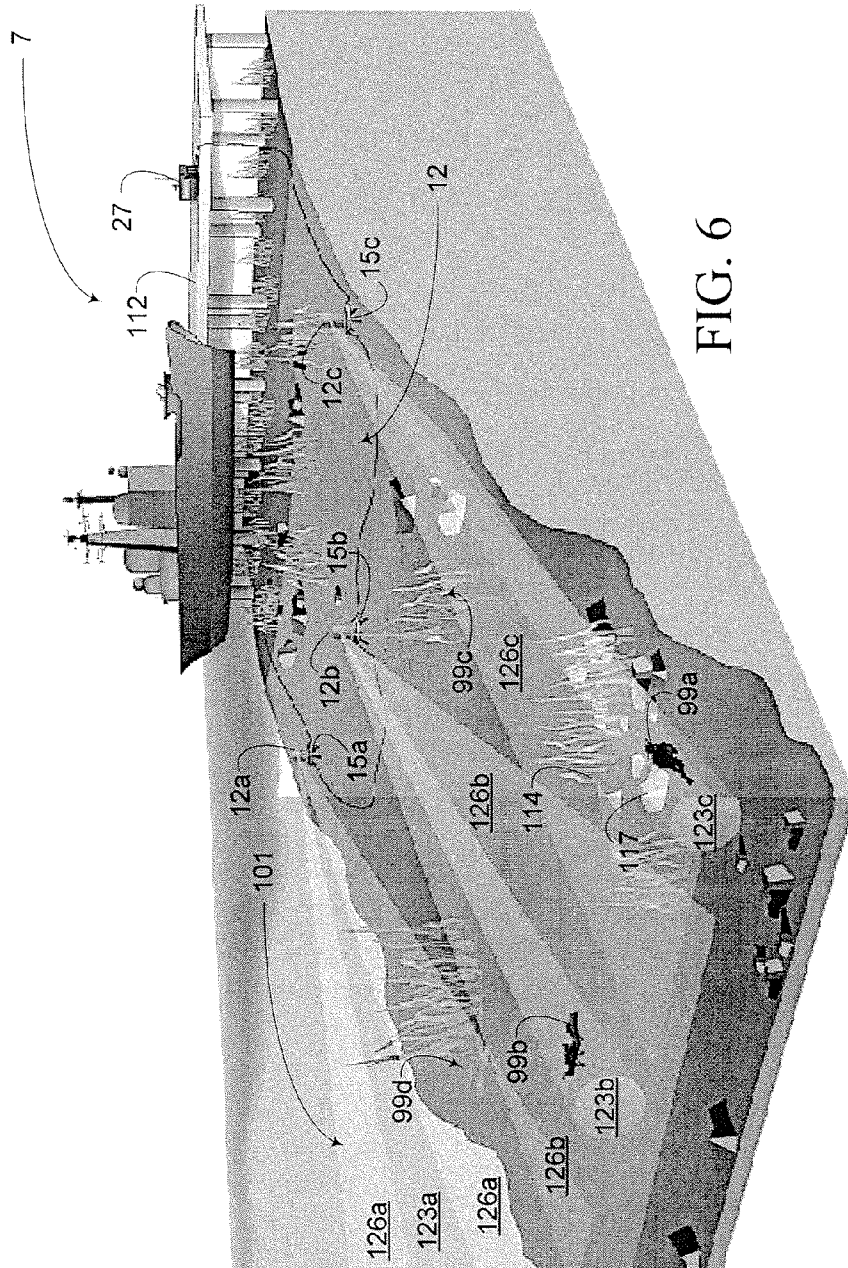

FIG. 6

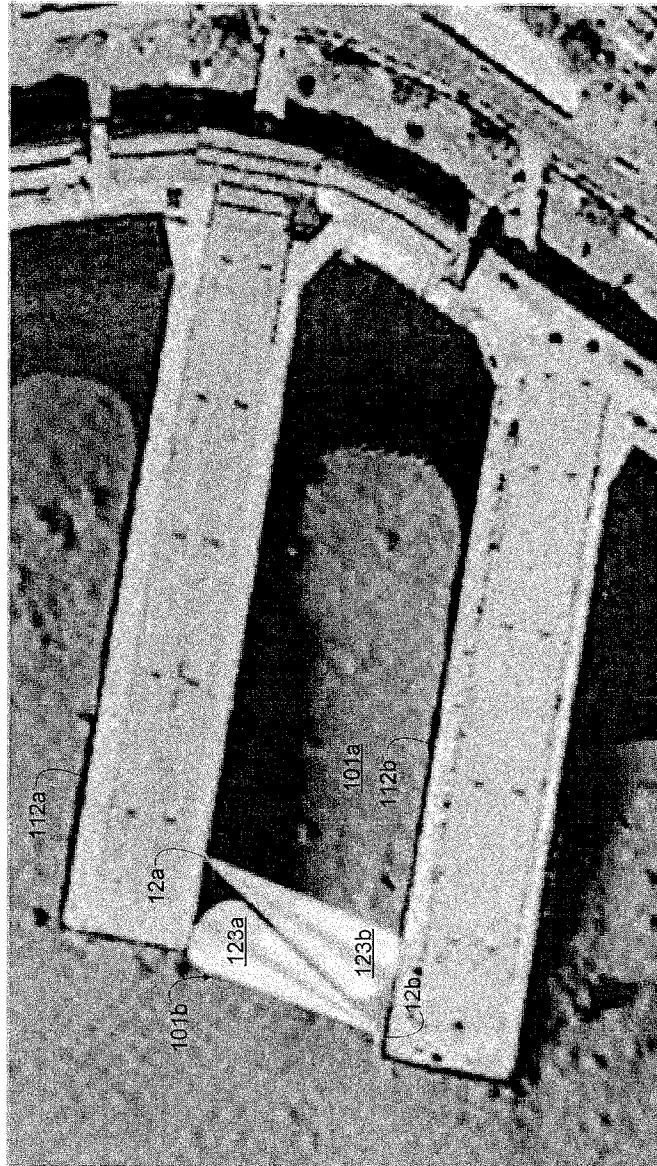
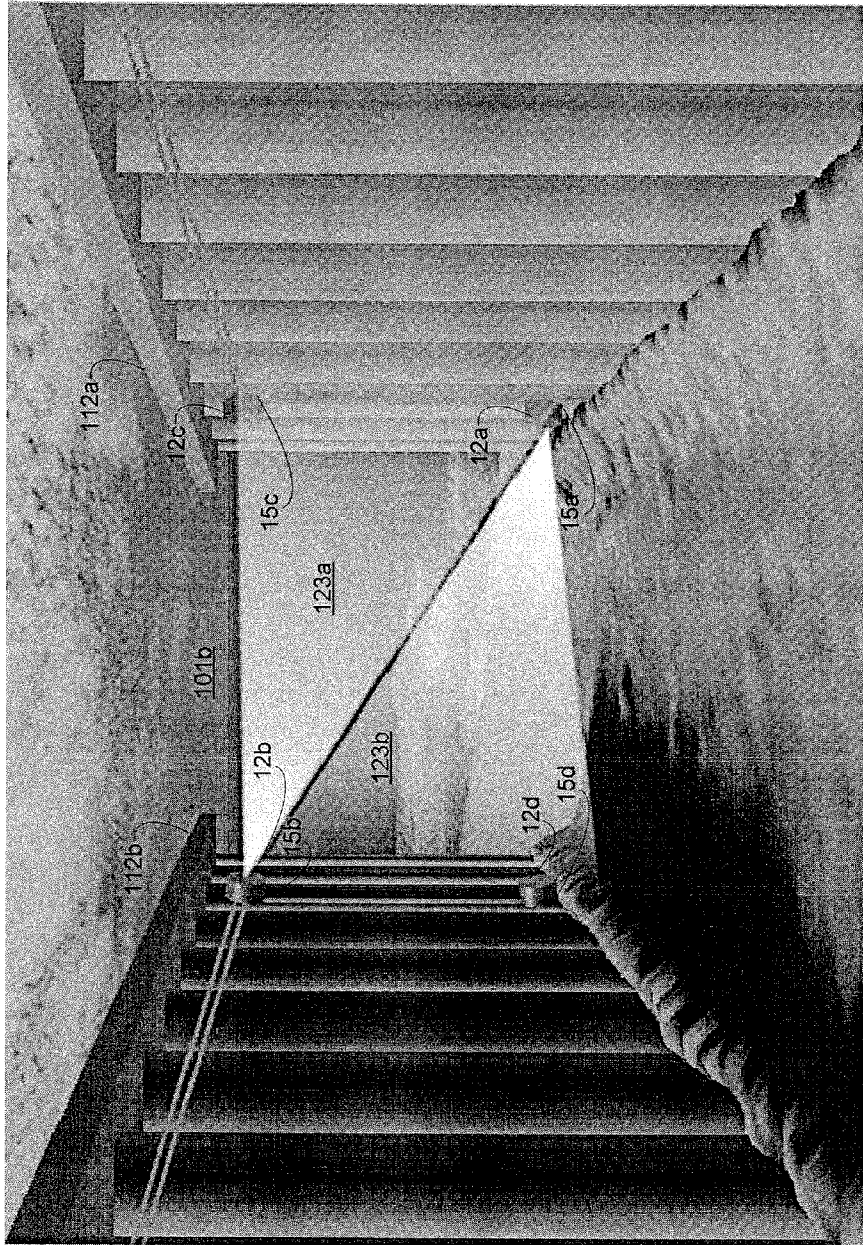

FIG. 7



12b
FIG. 8

NETWORKED SONAR OBSERVATION OF SELECTED SEABED ENVIRONMENTS

FIELD OF THE INVENTION

This invention relates generally to sonar and, more specifically, to collecting and compiling return data from networked sonar transducer assemblies.

BACKGROUND OF THE INVENTION

Whales, seals, sea lions, catadromous fish such as eels and anadromous fish such as shad and salmon all migrate through confined waterways such as Puget Sound or Alaska's Inside Passage. The main means of determining populations and movement have been through spotting, i.e. human observers at chokepoints. Chokepoints have been traditionally at passages through which the migrating population must pass. Where the passages have been synthetic and narrow, such as fish ladders, or at natural constrictions, such as the mouths of streams, the movement of the migratory population has been readily estimated by visual sighting. Generally, the narrower the constriction, the better the count.

Only anadromous fish, however, migrate into narrow streams where such counts are facilitated by constrictions in the migratory waterway. Cetacean species rarely enter freshwater streams and will not readily be counted in such confined waterways. Yet the whales do pass through some well-defined passages on their migratory routes.

Orca whales, for example, can be observed to move between Puget Sound in Washington, through the Strait of Georgia in British Columbia, then on to southeastern Alaska; traveling through Prince William Sound to the waters around Kodiak Island. Given the breadth of any of several inland passages, visual counting lacks a great deal of the certainty necessary to accurately gauge the extent of the Orca population as they migrate.

Complicating the count is the fact that within the same waters, Humpback, Grey and other cetacean species live and move. Discernment of one whale species from another in the same space is also necessary for accurately assessing the population. All of these species regularly pass through the same defined chokepoints in the inland waterways. Because whale movement is predictable and includes swimming through predicted passages, accurate counts could be obtained by monitoring the seabed environment at each of these chokepoints to discern passage.

Selected sonar frequencies have been found to detect whales without imparting injury to the whale's own sonar guidance system. Sonar, however, only propagates in a cone defining a solid angle. Counting schemes to date have placed the sonar across the mouth of a chokepoint. Very few chokepoints, however, can be effectively monitored by positioning a single solid angle cone, for doing so requires the assumption that the whales will pass in single file through the chokepoints. Ganging sonar installations has been one strategy for enhancing the accuracy of counting results by placing several transducers along the migration path and comparing results to come up with counts that are in good agreement. A second ganging strategy consists of filing a chokepoint with several transducer cones, stacked to completely and non-overlappingly fill the chokepoint, but such ganging suffers from a lack of coordination of results such that a single whale might be counted more than once by passing through each of several sonar cones. Additionally, finding such chokepoint spaces that are readily filled with such transducer cones is difficult.

What is needed, then, is a predictable means of monitoring defined chokepoints with coordinated sonar installations. Comprehensive monitoring of chokepoints in defined seabed environments facilitates counting by allowing in-depth observation of all movement within those seabed environments.

BRIEF DESCRIPTION OF THE DRAWINGS

The preferred and alternative embodiments of the present invention are described in detail below with reference to the following drawings.

FIG. 1 is a perspective view of a transducer assembly;

FIG. 2a is a perspective view of a networked sonar array with a single transducer assembly in networked communication;

FIG. 2b is a block diagram of the networked sonar array with the single transducer assembly;

FIG. 3 is a detailed block diagram of the networked sonar array with the single transducer assembly;

FIG. 4a is a seabed environment including surf zone bathymetry factors;

FIG. 4b is a seabed environment with the seawater removed to reveal surf zone bathymetry factors;

FIG. 4c is a detail of two rocks within the seabed environment;

FIG. 5 is a flow chart of analysis of the suppression algorithm;

FIG. 6 is a perspective view of a seabed environment with a networked sonar array in situ;

FIG. 7 is a plan view of a constricted seabed volume between piers; and

FIG. 8 is a perspective view of the seabed volume between piers.

DETAILED DESCRIPTION OF THE PREFERRED EMBODIMENT

By way of overview, a sonar transducer network for observing a seabed includes a controller. A first transducer assembly includes a first acoustic transducer to convert a first ping to a first electrical signal; and a first transducer processor to receive a first electrical signal from the first acoustic transducer to generate the first transducer data. At least one second transducer assembly is spaced apart from the first transducer assembly. The second transducer assembly includes a second acoustic transducer to convert a second ping to a second electrical signal. The second transducer processor receives the second electrical signal from the second acoustical transducer to generate second transducer data. A network bus communicates first transducer data and second transducer data with the controller.

Networked Transducer Assemblies with Two-Axis Mounts

FIG. 1 illustrates a non-limiting example of a transducer assembly 10 including a transducer electronics subassembly 12. The transducer electronics subassembly 12 includes a transducer processor (not shown) and a transducer (not shown) also referred to as transducer ceramics (referring to the fact that transducers commonly include piezoelectric ceramic transducers).

The transducer electronics subassembly 12 is mounted on a two-axis mount 15. The two-axis mount 15 serves as a platform not only for the transducer electronics subassembly 12 but also for such environmental sensors 18. By way of non-limiting example, environmental sensors include those

which measure environmental conditions such as temperature, salinity, and relative pressure.

Sound speed is slower in fresh water than in sea water. In all water sound velocity is affected by density (or the mass per unit of volume). Density is affected by temperature, dissolved molecules (usually salinity), and pressure. The speed of sound (in feet per second) is approximately equal to $4388 + (11.25 \times \text{temperature (in } ^\circ \text{ F.)}) + (0.0182 \times \text{depth (in feet)}) + \text{salinity (in parts-per-thousand)}$. This empirically derived approximation equation is reasonably accurate for normal temperatures, concentrations of salinity and the range of most ocean depths.

Ocean temperature varies with depth, but at between 30 and 100 meters there is often a marked change, called a thermocline, dividing the warmer surface water from the cold, still waters that make up the rest of the ocean. The presence of the thermocline can frustrate sonar, for a sound originating on one side of the thermocline tends to be bent, or refracted, off the thermocline. The thermocline may be present in shallower coastal waters; however, wave action will often mix the water column and eliminate the thermocline. Water pressure also affects sound propagation. Increased pressure increases the density of the water and raises the sound velocity. Increases in sound velocity cause the sound waves to refract away from the area of higher velocity. The mathematical model of refraction is called Snell's law. For these reasons, monitoring of ambient water temperature, salinity, and relative pressure optionally allows normalization of the speed of sound through the ambient water, thereby giving more precise ranging.

The Remote Ocean Systems™ two-axis pan and tilt mounts are one non-limiting example of a suitable two-axis mount. By way of further non-limiting example, a two-axis mount will include actuators for each axis including either of a reversible synchronous motor or a brushless stepper motor coupled to low backlash harmonic gearing. Optionally, rugged design of the gear train allows stalling of either output shaft without damage to the gears or the motors.

The two-axis mount is, optionally, equipped with internal limit switches and position feedback potentiometers on both axes. The potentiometers sense pan and tilt orientation angles for providing azimuth and depression angles (or "pan and tilt" angles) and present that information to the transducer processor (not shown) for inclusion in transducer data.

In the pictured embodiment of the two-axis mount 15 of the transducer assembly 10, a mounting flange 21 provides an advantageous means of affixing the two-axis mount 15 to a stationary hard point from which to operate.

Referring to FIG. 2a, an embodiment of a networked sonar transducer array 7 includes a transducer electronics subassembly 12, communicatively connected to a controller 27 by means of a network bus 24, in this case a waterproof Ethernet cable, through a network bus 24 including a fiber optic cable with suitable nodes or other such network means.

In a non-limiting exemplary embodiment, the communication between the controller 27 and any of at least one transducer electronics subassembly 12 is by means of addressing of packets from a sending node to a receiving node. In this application, the term Ethernet is used to reference all of the IEEE 802 LAN protocols, including but not limited to Token, FDDI, and ATM but because Ethernet has some common features with networking standards that are not part of the IEEE 802.3 Ethernet standard, but support the Ethernet frame format, and are capable of interoperating with it, the term Ethernet, as used herein any network over any bus such as a twisted pair; coaxial; fiber optic conduits; wave guides; or

wireless networks such as WiFi or Bluetooth, or, importantly, any combination of the busses.

Addressing of packets is handled on Ethernet, as on all IEEE 802 LANs, by giving each peer a unique 48-bit MAC address. Network adapters normally do not pass packets intended for other Ethernet cards to the host to improve performance but can also be placed in promiscuous mode where they pass every packet to the host. Adapters generally come programmed with a globally unique address but this can be overridden either to avoid an address change when an adapter is replaced or to use locally administrated addresses. The network bus 24 may be any network bus capable of supporting a LAN including the transducer electronics assembly 12.

By way of further explanation of the basic networked sonar transducer array 7, reference to FIG. 2a shows a block diagram of the network bus 24 including transducer interface cards 33, 36 and a controller interface card 51 shown in FIG. 2b. Representing the same elements shown in the perspective view that is FIG. 1, the embodiment of the networked sonar transducer array 7 includes the transducer electronics subassembly 12, communicatively connected to the controller 27 by means of the network bus 24. Additionally, the controller 27 manages the network bus 24 including assignment of the resources on the network by means of dynamic host configuration protocol (DHCP). DHCP is an Internet protocol for automating the configuration of computers that communicate using the TCP/IP protocol. DHCP can be used to assign IP addresses, to deliver TCP/IP stack configuration parameters such as the subnet mask and default router. DHCP transmits other configuration information to each of the components on a network and assigns addresses for the controller 27 and the several transducer interface cards 33, 36.

Network management is set forth in a non-limiting embodiment by a server section of the controller 27 called a network controller 45. By way of non-limiting example, a network controller 45 includes a processor configured to manage the network traffic without requiring dedication of host CPU cycles. The network controller 45 facilitates networked communication by processing TCP/IP communications. Using an autonomous network controller 45 prevents formation of a bottleneck within the controller 27.

The network controller 45 operates responding to instructions within an operating system stored in machine-readable form on the non-volatile memory 42. By way of non-limiting example, the non-volatile memory in an embodiment is identified as a chipDISK™, a fully IDE-compatible flash hard disk designed to replace the customary hard disk. The chipDISK™ is an example of a flash memory technology selected to ruggedize the controller 27 for use outside of a laboratory environment. Advantageously, flash memory is insensitive to tremors, vibrations, impacts, fluctuations in temperature and magnetic fields. Flash memory is, therefore, well-suited for use in mobile equipment and systems which need to withstand severe influences. Additionally, having a very small form factor, the flash memory allows the configuration of a more compact and therefore portable controller 27.

The remaining infrastructure necessary to support the controller network includes a transmitter card 51, along with a power amplifier board 48, and the power supply section 54. The power supply section 54 feeds the network controller 45, the power amplifier board 48, the transmitter card 51, and the non-volatile memory 52. The power supply board 54 feeding a logical power supply 5-volt regulator 57 provides power for logical switching circuits. In the non-limiting embodiment, the described elements of the controller 27 function as the principal server in the networked sonar transducer array 7.

At least one transducer electronics subassembly **12** is in networked communication with the controller **27**. The transducer electronics subassembly **12** includes a transducer processor **30**, itself including, by way of non-limiting example, network transmission **33** and reception boards **36** to enable communication through the network bus **24**, as well as a transducer **39**. The transducer processor **30** is further configured to drive a transducer **39** and to process the signals from the transducer **39** to create transducer data to be fed over the network bus **24** to the controller **27**. In one embodiment, the controller **27** time stamps transducer data and concatenates the time stamped transducer data with data including azimuth angle and angle of depression data.

The transducer **39** generates and receives sonar energy by means of piezoelectric ceramics. A variety of piezoelectric ceramics may be suitable for the fabrication of the transducer **39**. Often ceramic formulations are chosen to optimize a “Q factor,” a term used to describe a measure of “quality” of a resonant system. Resonant systems respond to frequencies close to their natural frequency much more strongly than to other frequencies. Systems with a high Q factor resonate with greater amplitude at the resonant frequencies than systems with a low Q factor. Enhancing the Q factor of the ceramic assures that reception of sonic energy within the band used for ranging will make the transducer both more sensitive and more discerning. A lower Q factor allows the piezoelectric ceramic transducer makes the transducer responsive to a wider range of frequencies. In some embodiments lower Q factors will facilitate a desired response, in others, a higher Q allows for dedicated use at a particular frequency. Alternatively, where a plurality of frequencies is desired, the single transducer electronics subassembly **12** may, optionally, contain multiple transmitters and receivers for each receiver transmitter pair being configured to operate at different frequencies.

Transducers **39** can operate as both transmitters and receivers, or they can be configured to be either solely transmitters or solely receivers depending upon electronics supporting the piezoelectric ceramic. Where a sonar installation includes a distinct transmitter and a distinct receiver, a shared timing signal is necessary to measure transit time for a ping traveling between the transmitter and receiver through a medium such as seawater. Time stamping pings at the receiver after generating pings at known times provides a calculable transit time.

One advantage of a networked sonar transducer array **7** is that each component of the transducer array operates with access to a network time signal that, advantageously can also be used to time components of the sonar transducer array **7**. That network time signal can be used to clock acoustical emissions and receptions at distinct transducers **39**, allowing operation analogous to that of bistatic radar. In bistatic operation, a single emitter transducer **39** can ping a plurality of targets within the monitored seabed environments **101** and the ping can be reflected and subsequently received at a number of distinct directional receiver transducers **39**.

Piezoelectric ceramics exploited as transducers **39** may be optionally configured for specific transmission or reception tasks. For instance, where a desired function of a one of the networked transducers **39** is to serve as a “trip wire,” the piezoelectric ceramic might be configured to be horizontally omnidirectional, i.e. having a beam pattern that is virtually equal in all horizontal directions. By transmitting a single ping that is, in turn, heard by a number of placed receivers, changes in a seabed environment **101** may be noted and localized. In that fashion, detection of movement within the broad scope monitored by the several receiving transducers can serve to initiate further probing action. The controller **27**,

in response to the detected movement, directs the distinct transducer assemblies **12** to derive further information from the area in the seabed environment **101** where the movement was detected.

The ability to craft distinct configurations of piezoelectric ceramics is particularly exploitable in the context of networked sonar transducer array **7**. By selectively fabricating transducers **39** for distinct capabilities and configuring the placement of the transducers within a monitored submarine environment **101** to exploit the selected characteristics of the fabricated transducers **39**, coverage of the seabed may be tailored for optimal detection of change within the seabed environment **101**. A networked sonar transducer array **7** may include narrow-beam, split-beam, side-scan and wide-beam transducers selected for the particular assignment within the seabed environment **101**. For instance, sidescan transducers **39** are designed for a focused directional beam pattern to the side and may be advantageously exploited to monitor elongate margins of the designated seabed environment **101**.

In a further embodiment, several transducers **39** are ganged as an array within a single transducer electronics assembly **12**, allowing the transducer processor **30** to switchably address any one of the several transducers **39** arranged together as a system. By doing so, the transducer electronic subassembly **12**, as a system, can change its focus on the seabed as the controller **27** dictates. An analogous situation is presented by the user of bi- or tri-focal glasses. As needed to observe an object of interest, the user selects the lens that will yield the most information to the user, generally by casting the eyes to see through the selected lens.

Similarly, the single transducer electronics subassembly **12** can be selectively configured to activate distinct piezoelectric ceramics **39** without physical replacement but rather by switching that selectively includes one or another piezoelectric ceramic **39**, according to the sonar configuration designed for the seabed, thereby removing the expense associated with placement of multiply and distinctly packaged electronics subassemblies **12** for each intended focus. In such non-limiting exemplary embodiments, the transducer processor **30** is selected to included the ability to switch between the several transducers **39** according to direction from the controller **27**.

As explained above, the transducer electronics subassembly **12** may advantageously communicate between the controller and the several distinct transducers by means of one or several network interface cards **33**, **36**. As earlier indicated in the discussion of FIG. 1, a second network interface card optionally might be dedicated to receiving information from the environmental condition sensor **18** (FIG. 1) and conveying it from the transducer processor **30** to the controller **27**, in one of several embodiments. Alternately, the transducer processor **30** may perform normalization of the received echo timings based upon observed environmental conditions.

Referring now to FIG. 3, the networked sonar transducer array **7** is shown to include the several data and signal processing capabilities necessary to more fully exploit the data gathering capabilities of the networked sonar transducer array **7**. It should be noted that for the sake of discussion, the dual functions of the controller **27** and a number of physical elements it comprises are duplicated in FIG. 3. This alternate embodiment does not require distinct elements but rather illustrates that the function of providing 5 volt regulation might be handled by a single 5 volt regulator even though two distinct 5 volt regulators **57**, **81** are shown in the diagram. Similarly, the network bus **24** and a rotator cable **24a**; the hard disk **60**, **87**; the non-volatile memory **42**, **90**; and the proces-

processor **45**, **84** are each shown as distinct elements but any or all of them may, in the prudent practice of the invention, be embodied by a single physical unit.

The heart of the controller **27** is the processor **84**. The processor receives data from a plurality of the transducer electronics subassemblies **12** and sorts the data to give a comprehensive picture of the monitored seabed. The processor **84** tasks each of the transducer electronics subassemblies **12** to specifically monitor an assigned sector according to instructions transmitted to the assembly through the transmitter board **51** over the network bus **24** to the receiver network interface board **36** to selectably select a transducer **39** to specifically observe regions within the seabed. The Ethernet switch **75** suitably correlates data according to its source in order to facilitate addressed communication within the network **24**, identifying both the source and the destination of data. Data generally streams to the processor **84** from the transducers **39** and commands flow down to the transducers **39**. By such means, the identify data is associated with its source transducer electronics subassembly **12**.

In an alternate embodiment, instructions for the processor **84** reside in a machine readable form on the non-volatile memory **90**. The processor **84** receives the data from the transducer **39** and builds a picture in a buffer corresponding to the transducer **39** on the hard drive **87**. To the extent necessary to observe a particular region based upon an orientation of the two-axis mount **15** (FIG. 1), the processor **84** generates instructions to suitably orient the transducer **39** relative to the mount **15**. The processor **84** generates drive instructions and sends them through the motor control **69** down the rotator cable **24a**. The drive instructions are received within the transducer electronics subassembly **12** at the dual axis rotator **63**. The dual axis rotator **63** suitably activate the mount **15** and its attendant actuators to orient the transducer **39** while the potentiometers (not shown) sense pan and tilt orientation angles. The azimuth and depression angles that the dual axis rotator **63** communicates back to the processor **84** then confirm the alignment of the transducer **39**.

The processor **84** populates the several buffers on the hard disk **87** to produce complete pictures of the monitored seabed from each of the plurality of transducer electronics subassemblies **12**. The processor **84** further compares the data received to determine if some aspect of the data matches any of a number of alarm states recorded in the instructions stored in machine readable form on the non-volatile memory **90**. If the data matches one of the alarm state, the processor **84** feeds suitable instructions to the relay unit **93** which suitably activates either or both of a strobe **99** or a speaker **96** with an annunciated warning according to the particular alarm state.

Benchmarks in Seabed

Advantageously, in most instances where a submarine environment **101** is to be monitored, detailed bathymetric data exists to reveal the contour and significant features of the submarine landscape. From a vessel, raw sonar data is collected using the sonar sensors. To calculate the precise position of the vessel, a computer constantly monitors the vessel's position according to a GPS system. Heave, pitch and roll data from the vessel's motion sensor and tide information from the tide gauge are input to condition and normalize the data. The large quantities of data returned from the site survey (typically hundreds of megabytes) are processed to provide a high resolution digital terrain map (DTM) with a typical positional resolution of 5-10 centimeters and a depth resolution of 1 centimeter in one non-limiting example. The DTMs are rendered using seabed visualization software.

Sonar technology is not the only method of gathering seabed topography. Underwater photography or video can provide the most detailed view of the seafloor. However, the cameras are limited to short distances as the artificial light does not penetrate the seawater effectively. In some cases visibility is degraded due to disturbed sediment and other environmental factors. Cameras placed on a remotely operated vehicle (ROV) can be used to gather data to augment the data resulting from rendering.

Satellite technology is another method that can be used to map the seafloor since, due to gravity, the shape of the sea surface is closely related to that of the seafloor. The depth of the ocean can vary by approximately 200 meters solely from the gravitational pull of large underwater seamounts such as an underwater volcano. Conversely, the ocean surface can downwarp over seabed trenches. Satellites measure the time it takes to bounce radio waves off the surface of the ocean and therefore calculate the height of the sea surface. Ocean topography using satellites can provide a global view of the ocean floor but generally lack the precision provided by sonar. When the several data collection methods are used in conjunction, one with the others, a very accurate rendering of the seabed is derived from the surface elevations.

Based upon an accurate and detailed view of the seabed, a networked sonar transducer array is designed to sense the seabed and the submarine environment **101** above the seabed. Referring to FIG. 4a, the surf zone seabed **101a** is portrayed with seawater present and as having several notable shoreline features, such as a groin **102**, opposing jetties **105** and **108** and a pier **112**. Not themselves seabed features, these marine features are indicative of corresponding submarine features that will make up the fixed seabed.

Referring to FIG. 4b, the bathymetric features such as the sandbars **102a** encompassing the groin **102**, the footings **105a** of the jetty **105**, and the pilings **112a**, **112b**, and **112c** become evident, as do other features such as canyon rocks **114**, **117**. These submarine features represent irregularities in the seabed; they are fixed, and observation of the seabed by sonar means will repeatedly produce echoes indicative of these fixed features of the seabed. Once known, display or analysis of these features is redundant and uninteresting for purposes of monitoring the seabed environment **101**, but are extremely important in a process of placing transducer assemblies **10** (FIG. 1) in the networked sonar transducer array **7** (FIG. 2a) within the seabed environment **101**.

Given the fixed nature of the several submarine features, the data obtained by the sonar survey is used to establish a baseline of ambient noise and reverberation, and fixed and assumed uninteresting physical targets, which may be present in the field of view. The processor **84** is programmed to "map" these features into memory. Any number of features are mapped into memory given their fixed and repeatable nature. Examples of these features include pilings, ship hulls, sea walls, aquatic vegetation and the seafloor itself.

Once the submarine terrain is known and the features isolated, the transducer assemblies **10** (FIG. 1) of the networked sonar transducer array **7** (FIG. 2a) are placed within the submarine environment **101**. As indicated above, a transducer emits in a solid angle cone. Efficiently packing the submarine environment **101** with solid angle cones is readily accomplished by space packing algorithms and aided by the criteria that overlap of cones allow placement of the transducers **39** (FIG. 2b) to suitably overlap downrange. Due consideration is taken of placement of sensor to assure visualization of each of the features within the seabed environment **101**. For instance, the seabed terrain includes two canyon rocks **114**, **117**. As the rocks **114** and **117** rest within a seabed canyon,

placement of the transducer **39** (FIG. **2b**) will duly exploit alignment of the cone with the canyon to allow a clear “view” of the canyon rocks **114**, **117** from the selected transducer site (not shown).

Once transducers **39** (FIG. **2b**) are placed, the background collection phase begins with a scan of the seabed environment **101**. Scanning includes “pinging” or generating “pings” which are short pulses of sound energy generated to propagate from the transducer **39** (FIG. **2b**) through the submarine seabed environment **101** and used for ranging. Scanning is pinging while the transducer **39** (FIG. **2b**) resides in a variety of orientations to build a composite of the submarine seabed environment **101** as the transducer **39** receives reflected pings.

When the networked sonar transducer array **7** performs the scan of a particular sector of seabed environment **101** the two-axis mount **15** (FIG. **1**) drives each transducer to many different orientations during the course of the scan. Additionally, transducers **39** are optionally placed within the seabed environment **101** in a configuration to assure that each feature in the seabed environment **101** is viewed by at least one transducer **39**. At any particular orientation, an emitted ping will encounter certain static structures present in the environment **101**, for example, pilings or the bottom. The background collection phase consists of collecting acoustic data while scanning the transducer through the entire path of the scan. Ideally, the background collection phase is run long enough for several pings to be collected for each bin of orientations (for example, each 1-degree cone). The size of the orientation bins is configurable by the user.

Bistatic imaging may also optionally be used in a similar fashion to generate further data as to the nature of the seabed environment **101**. Bistatic imaging is a technique for using two transducers **39** (FIG. **2b**) to map a surface, with one emitting and one receiving. The bistatic imaging yields a more detailed image than would have been rendered with just the transducer **39** (FIG. **2b**). Bistatic imaging can be useful in differentiating between different sonary surfaces, due to the different ways that sound reflects off of these objects (transducers detect “volume scattering” from less solid surfaces). Additionally, bistatic imaging allows for monitoring spaces between two transducers **39** (FIG. **2b**).

Epipolar geometry is the intrinsic projective geometry between two views. Resolution of the spatial relations between selected points is independent of scene structure, and only depends on the transducers’ **39** (FIG. **2b**) internal parameters and relative pose. The epipolar geometry between two views is essentially the geometry of the intersection of the image planes with the pencil of planes having the baseline as axis (the baseline is the line joining the transducers **39** (FIG. **2b**) centers). Resolving spatial relations is based upon epipolar geometry to assist in the search for corresponding points in stereo matching.

At the end of the background collection process, the pings in each orientation bin are averaged to get a representation of the static structure encountered by the acoustic beam when it is in that orientation. The scan can suitably be correlated with the results of the initial sonar survey of the seabed environment **101**.

Referring to FIG. **4c**, the hard features in the seabed environment **101** such as the canyon rocks **114**, **117**. Such known submarine terrain features are compared to the timings of the received pings in order to solve for a transform from one mapping by one transducer **39** (FIG. **2b**) to the next. Kalman filtering is optionally used to solve for such a transformation relative to the monitored seabed environment **101**. Because the solution of the transformation need not be done in “real

time” iterative processing of the Kalman filter can be used until the spherical coordinates generated at a first transducer **39** (FIG. **2b**) of returned pings from its surrounding environment **101** can be used to relate the returns from the first transducer **39** (FIG. **2b**) to those of a second transducer **39** (FIG. **2b**). Once a solution is derived between each of the transducers **39** (FIG. **2b**) and each of the remaining transducers **39** (FIG. **2b**), the whole of the seabed environment **101** can be described in spherical coordinates from at least one, but generally two transducers **39** (FIG. **2b**) in the seabed environment **101**.

Spatial Model

Once the whole of the seabed environment **101** is mapped relative to each of the transducers **39** (FIG. **2b**), monitoring of the seabed environment **101** is more readily achieved. The seabed features that are static, having already been used to solve for the suitably transforms between the coordinates as “viewed” from each of the transducers **39** (FIG. **2b**), now become the boundaries of relevant returns. For purposes of monitoring the environment **101**, no reason exists to expend computer resources for resolving range bins outside of the boundaries defined by the static features. The boundaries of relevant returns are then mapped to form a by-pass map uses for suppression selection.

Referring to FIG. **5**, a filtering method **200** includes examining each range bin for suppression according the by-pass map. Commencing at a block **201**, the method continues to determine if the range bin is spatially located within an area where suppression is advantageous at a block **204**. Most of the range of any of the transducers **39** (FIG. **2b**) includes monitorable space; indeed, the placement of the transducers **39** (FIG. **2b**) was based upon optimizing the portion of the seabed environs each of the transducers **39** (FIG. **2b**) could monitor. In some instances, activity with a region is known and not considered advantageous to monitor. By way of non-limiting example, when a vessel passes through an area being monitored for cetacean activity, the vessel is known in order to well track what activity exists around the vessel, suppression of returns from the vessel prevents those returns from overwhelming the other information discernible in proximity to the vessel. Because the vessel would not be on the by-pass map, it not being a static feature of the seabed environs, an option allowing the operator to suppress the returns at the vessel is useful.

If the range bins are outside of the operator defined area for ad hoc suppression, the method proceeds checking if the range bin is one identified by the by-pass map for suppression at a block **207**. If not, the range bin is stored unaltered in the buffer at a block **213** and at a block **297**, the analysis proceeds to the next range bin in question.

If, at the block **207** the range bin is found on the by-pass map, at a block **210**, the returns in the range bin are suppressed according to the filter information stored in the by-pass map. Once the returns are suitably suppressed, the returns are stored in the buffer, and at the block **297**, the analysis proceeds to the next range bin in question.

Where there are no objects that require operator selected local suppression, an operator will select a setting of “0” meaning “no local suppression is requested” and thus, at a block **216**, the method determines that no suppression is requested and the method, at a block **219**, stores the unaltered range bin in the buffer and then at the block **297**, moves to the next range bin.

If, on the other hand, the operator has selected either of settings “1” or “2” meaning that either of “selective suppres-

11

sion” “suppression according to suppression map,” respectively, are selected, at the block 216, the method moves to determine suitable suppression.

A word about the suppression map is appropriate. In this non-limiting example, the suppression map is a map of filter values selected based upon the seabed terrain and the operator’s “tuning” of results to achieve appropriate sensitivity throughout the range. The suppression map is a result of the operator’s experience and not based upon autonomous responses of the system.

In the selective suppression mode or operator selected “1” mode, the by-pass map and the suppression map are selectable but deference is given to the by-pass map. If the operator selected is detected at a block 222, the method queries the by-pass map to determine if a by-pass filtering value is associated with the location of the range-bin under analysis, at a block 225. If no by-pass map entry exists, at a block 231, the range bin value is stored in the buffer and at the block 297, the analysis moves to the next range bin.

If a value exists on the by-pass map associated with the spatial location of the range bin, the value is suppressed according at a block 228 and stored in the buffer. Then, the method moves to the next range bin for analysis at the block 297.

Where the operator has selected mode “2” only the suppression map is applied to the range bin returns. Thus, at a block 234, the selection of mode “2” is verified. At a block 237, the suppression stored in association with the range bin spatial location is applied to the range bin return and at the block 297, the analysis moves to the next range bin.

Non-Limiting Example of Use of the Networked Sonar Transducer Array

Referring to FIG. 6, an example drawn from a test of the system is illuminating. In an underwater environment 101 a number of existing hard targets such as canyon rocks 114, 117 exist as part of the static members of the environment 101. For the purposes of this non-limiting example, these are presumed to be already mapped relative to each of the several (in this exemplary case, three) transducer subassemblies 12a, 12b, 12c on their respective two-axis mounts 15a, 15b, 15c configured as a network of transducer subassemblies 12. In this non-limiting example, each of the transducer assemblies have a narrow-angle cone 123a, 123b, and 123c systematically scanning a defined azimuth 126a, 126b, 126c, and for surveillance of the underwater environment 101. In response to commands generated either autonomously or sent to the transducer assembly network 12 for an individual transducer assembly, 12b for example, from the controller 27, the transducer assemblies may switchably select scanning the azimuth 126 in a systematic pattern or training narrow-angle cones 123 for surveillance of designated point in the underwater environment 101.

Presumed in this example is that the whole of the underwater environment 101 is suitably mapped by the above-described methods relative to each of the transducer subassemblies 12a, 12b, 12c and by means of epipolar geometry all of the spatial relationships between the terrain including hard targets within the underwater environment 101 have been suitably related to each of the transducer assemblies 12a, 12b, 12c to generate a three-dimensional buffer representing the space.

As the networked sonar transducer array 7 monitors the underwater environment 101 for movement within the underwater environment 101, all echoes that would emanate from the known static elements such as the canyon rocks 114, 117

12

are, in at least one embodiment, suppressed from analysis or, optionally, from a graphic display of the space generated for operators, as these static elements are known not to be migrating fish or other targets 99 of interest within the environment 101. Thus, where some dynamic element within the environment 101, initiates a movement that is detectable by at least one of the arrayed transducer assemblies 12a, 12b, 12c, that movement may be tracked relatively easily independently of the echoes emanating from known static elements within the environment 101.

In at least one embodiment, alarming based upon movement within the environment 101 is considered to be very useful. For instance, where the selected underwater environment 101 is at a choke-point in a migratory pattern, and where the sort of echoes that might be returned from dynamic elements in the space are known by certain characteristics, movement of such dynamic elements may, itself, be an event of note, signaling, for example, the return of such a long migratory as an Orca to a territorial water. If “enough” such echoes are received at the transducer assemblies 12 (based on a user-configurable sensitivity parameter), then an alarm condition is signaled. The actual signaling may be designated to take the form of triggering relays connected to alarm devices such as a siren or a strobe light, or it may include sending out information over a second network (distinct from the arrayed transducer assemblies 12) about the position of the dynamic element. Optionally, alarming includes generating a displayed icon at a position correlating with the position of the dynamic element within the environment 101. Such an icon might be placed in a three-dimensional representation of the environment 101 or in the more traditional plan position indicator (PPI) display used in radar applications.

To test the efficacy of the networked sonar transducer array 7, targets are introduced into the underwater environment 101. One exemplary target, a diver 99a presents a minimal profile to the transducer assembly 12c as the diver 99a swims within the wide-angle cone 126c. Alerted to the changing state within the ambit of the wide-angle cone 126c, either autonomously or at the command of the controller 27, the transducer assembly 12c switches from systematically scanning the azimuth 126c to training the narrow-angle cone 123c to enable examining the diver 99a with the greater discernment that repeated pinging with the narrow-angle cone 123c provides. Optionally, the controller 27, may order the adjacent transducer assembly 12b to pivot on its two-axis mount 15b to further examine the diver 99a. Generally the narrow-angle cone 123b can be trained on the diver 99a given the epipolar geometric solution already solved for the whole of the underwater environment 101. Advantageously, the diver 99a cannot present the minimal cross-section to both transducer assemblies 12b, 12c. For this reason, probability of discernment of the diver 99a as a target of interest is greatly enhanced by the simultaneous sensing of the diver by the distinct transducer assemblies 12b, 12c.

In a second instance, the same non-limiting example of the transducer assembly network 12 includes a diver 99b using a diver propulsion vehicle such as a tow behind scooter. Diver propulsion vehicles are used in testing to give distinct velocities and movement to the target. Similarly, the response from the system by way of non-limiting example is the same, except to the extent that the transducer assembly 12b is implicated as monitoring the test area within the underwater environment 101. As a distinct example, the transducer assembly 12b switches from scanning the azimuth 126b to training the narrow-angle cone 123 on the diver 99b to track the diver 99b, while the adjacent transducers 12a and 12c pivot on their respective mounts 15a, 15c to expand their respective azi-

muths **126a**, **126c** to include portions of the azimuth **126b** that had been monitored by transducer assembly **12b** thereby maintaining suitable surveillance of a perimeter of the underwater environment **101**.

Having the transducer assemblies **12a**, **12b**, and **12c**, each themselves being trainable in response to the controller **27**, the networked sonar array **7** can suitably study any movement of a dynamic element within the underwater environment **101**. Another non-limiting example of a response to movement of dynamic elements with the underwater environment **101** is presented by the presence of a school of fish **99c** within the underwater environment **101**.

Movement of fish **99c** through an underwater environment **101** is generally by known means. Fish will travel at known velocities, school in generally known fashions, and present a reflectivity to sonar that can be predicted. From species to species, these parameters may vary, but within a known species, study and cataloging will allow classification of schools of fish or other marine life according to its species and number. Doing so, however, will not be the result of one or two "pings" from a transducer assembly **12b** but rather the collection of observed echoes over a period of time. To collect such information, one transducer must be trained on the school while others in the networked sonar array **7** can be retasked in response to the controller **27**, the networked sonar array to observe movement of a dynamic elements within the underwater environment **101**. In this fashion, the focus of the networked array can be both on individual "trees" while maintaining an eye or rather an ear on the "forest."

In a fourth non-limiting example, if the species of interest is cetacean, biological species even in schools will not be sufficiently reflective as to be of interest. A whale has mass and volume that presents a large and reflective target to sonar. A school of fish such as anchovy **99d** will not reflect sonar energy in the manner of whale. Whales have a relatively unvarying volume, well-defined margins, and a greater reflectivity than do a school of anchovy **99d**. Whales do not dart from one position within the underwater environment **101** to a second position. Where for the purposes of studying whale movement, the networked sonar array can identify the school of anchovies **99d** as anchovies, the most prudent deployment of resources may simply be to filter out returns from the school of anchovies **99d** and to continue to allow each of the transducer assemblies **12a**, **12b**, and **12c** to continue to monitor their respective azimuths **126a**, **126b**, and **126c**. Using such a non-limiting exemplary strategy allows maximum discernment of desired targets **99** within the underwater environment **101** by sacrificing knowledge of the exact movement of non-interesting targets within the underwater environment **101**.

While several strategies have been shown to describe the capabilities of the networked sonar array **7**, the purpose of the description is not to limit the networked sonar array to a number of taught responses to targets **99** within the underwater environment **101**, but rather to indicate the flexibility of the networked sonar array **7** in response to targets of various interest within the underwater environment **101**. Capabilities of the array **7** are the object of the teaching in this non-limiting disclosure and strategies may vary in accord with the intended subject of study. That the individual transducer assemblies **12a**, **12b**, and **12c** are not required to observe fixed and unvaried azimuths **126a**, **126b**, and **126c** results from the independent training of the transducer assemblies **12a**, **12b**, and **12c** responsive to signals received from the controller **27**.

One virtue of the networked sonar array is that the selection and tasking of transducer assemblies **12** may be according to the underwater environment **101** to be observed. Where, for instance, the underwater topography includes some of the features discussed in relation to FIGS. **4a** and **4b** above, selecting and positioning transducer assemblies **12** might well be accomplished through the selection of specialized transducers.

By way of explanation, the non-limiting example of a volume of the underwater environment **101** positioned between two piers might be a focus of study, especially, where as in this non-limiting example, pilings are spaced such that whales may only enter and leave the volume by passing between two extreme ends of the pair of piers.

Referring to FIG. **7**, a first pier **112a** is parallel and spaced apart from a second pier **112b** and encompassing an underwater volume **101a**. A second view from within the underwater volume **101a** looking through the mouth **101b** is presented in FIG. **8**. At corresponding extreme ends of the piers respective transducer assemblies **12a** and **12b** are trained to provide a picket that covers a gateway or mouth **101b** to the underwater volume **101a**.

Referring to FIGS. **7** and **8**, the transducer assemblies **12a** and **12b** are selected to be wide-angle transducer assemblies, that is to say transducer assemblies having wide-angle cones **123a** and **123b** respectively. Once mounted on the respective piers **112a** and **112b** respectively, the transducer assemblies **12a** and **12b** are trained to assure that the wide-angle cones **123a** and **123b** generally occlude the mouth **101b** with minimal overlap. Frequencies for the transducers are selected to generate optimal responses from the environment (for instance to penetrate silt of plankton known to be present). The operator may also select an optimal number of range bins within each of the cones **123a** and **123b**.

Placement of the transducer assemblies **12a** and **12b** in this "picket" formation completely filling the mouth **101b** of the volume **101a**, monitors movement into the volume without requiring that all of the volume **101a** be constantly monitored. Thus, for example where an activity such as spawning may occur within the area but such spawning need not itself be observed, the perimeter picket yields all of the information of note. Where additional information is necessary, two transducer assemblies **12c** and **12d** are mounted but not activated or trained until the need arises or at such time when the controller **27** (FIG. **6**) generates orders to "exercise" the two-axis mounts **15c**, **15d**.

Additionally, the non-limiting deployment of the transducer assemblies **12a**, **12b**, **12c**, and **12d** on their respective two-axis mounts **15a**, **15b**, **15c**, and **15d** allows for redundancy in guarding the mouth **101b**. Alternately, the transducer assemblies **12a** and **12b**, can be placed in the secondary job of tracing targets of interest by the controller **27** (FIG. **6**) while then using the transducer assemblies **12c** and **12d** to provide the picket in a symmetric fashion to that illustrated in FIG. **8**.

While the preferred embodiment of the invention has been illustrated and described, as noted above, many changes can be made without departing from the spirit and scope of the invention. Accordingly, the scope of the invention is not limited by the disclosure of the preferred embodiment. Instead, the invention should be determined entirely by reference to the claims that follow.

15

The embodiments of the invention in which an exclusive property or privilege is claimed are defined as follows:

1. A sonar transducer network for observing a seabed comprising:
 - a controller;
 - a first transducer assembly at a first network node including
 - a first transducer to convert a first ping to a first electrical signal; and
 - a first transducer processor to receive a first electrical signal from the first transducer to generate the first transducer data;
 - at least one second transducer assembly at least one second network node, the second transducer assembly including:
 - a second transducer to convert a second ping to a second electrical signal; and
 - a second transducer processor to receive the second electrical signal from the second transducer to generate second transducer data;
 - a network bus to communicate first transducer data through the first node and second transducer data through the second node with the controller; and
 - wherein at least one of the transducer assemblies includes:
 - an at least two-axis mount affixed to the transducer the two axis mount having:
 - an azimuthal actuator configured to orient the transducer to an azimuth angle responsive to the transducer processor; and
 - a depression actuator configured to orient the transducer to a depression angle responsive to the transducer processor.
2. The sonar transducer network of claim 1, wherein:
 - the network bus includes:
 - a controller network interface communicatively connected to the controller;
 - the first network node includes
 - a first addressable transducer network interface communicatively connected to the first transducer processor;
 - at least one second network node includes
 - at least one second addressable transducer interface communicatively connected to the at least one second transducer processor; and
 - a network conduit communicatively connected to each of the controller network interface; the first transducer network interface; and the at least one second transducer interface.
3. The sonar transducer network of claim 2, wherein:
 - the network interfaces include Ethernet interfaces; and
 - the network conduit includes an Ethernet cable.
4. The sonar transducer network of claim 3, wherein:
 - the network interfaces include fiber optic network interfaces; and
 - the network conduit is a fiber optic conduit.
5. The sonar transducer network of claim 1, wherein:
 - the transducer processor includes an analog to digital converter in communication with the transducer.
6. The sonar transducer network of claim 1, wherein:
 - the transducer assembly includes environmental sensors to measure at least one of environmental condition in the seabed proximate to the transducer selected from a group consisting of:
 - temperature;
 - salinity; and
 - relative pressure.

16

7. The sonar transducer network of claim 6, wherein:
 - the transducer processor is configured to normalize transducer data based upon the at least one environmental condition.
8. The sonar transducer network of claim 6, wherein:
 - the transducer processor is configured to communicate the at least one environmental condition to the controller; and
 - the controller normalizes the transit times based upon the at least one environmental condition.
9. The sonar transducer network of claim 1, wherein:
 - the transducer data includes:
 - at least one transit time measured at a temporal moment; and
 - a timestamp identifying the temporal moment.
10. The sonar transducer network of claim 9, wherein:
 - the transducer datum includes the azimuth angle and the depression angle measured at the temporal moment.
11. The sonar transducer network of claim 10, wherein:
 - the controller includes:
 - a first buffer to store first transducer data according to temporal moment, azimuth angle, and depression angle.
12. The sonar transducer network of claim 11, wherein:
 - the controller is configured to generate a three-dimensional model of static elements of the seabed based upon first transducer data.
13. The sonar transducer network of claim 12, wherein:
 - the controller includes a second buffer to store second transducer data according to temporal moment, azimuth angle, and depression angle; and
 - the controller is further configured to refine the three-dimensional model based upon second transducer data.
14. The sonar transducer network of claim 12, wherein:
 - the controller is further configured to suppress returns from targets based upon a position relative to the static elements of the three-dimensional model.
15. A method of observing seabed comprising:
 - locating a plurality of benchmarks within the seabed;
 - positioning a first transducer assembly suitably to generate first transducer data to include data from remotely sensing each of the plurality of benchmarks within the seabed at the first transducer assembly;
 - positioning at least one second transducer assembly spaced apart from the first transducer assembly suitably to generate at least one second transducer data to include data from remotely sensing each of the plurality of benchmarks within the seabed at the at least one second transducer assembly;
 - receiving the first and the at least one second transducer data at a controller; and
 - storing first transducer data in a first buffer and the at least one second transducer data in at least one second buffer according to a temporal moment, azimuth angle, and depression angle.
16. The method of claim 15, further comprising:
 - identifying data from each of the plurality of benchmarks in the first buffer as first benchmark data;
 - identifying data from each of the plurality of benchmarks in the second buffer as second benchmark data; and
 - correlating first benchmark data with second benchmark data to generate a parallax image of the benchmarks from the first transducer data and the at least one second transducer data.

17

17. The method of claim **16**, further comprising:
generating a digital elevation model of seabed based upon
the parallax image, the first transducer data, and the at
least one second transducer data.

18. The method of claim **17**, wherein the generating on the 5
digital elevation model includes:

mapping a first plurality of first point data in the first
transducer data relative to the first transducer assembly
to develop a first locus set;

mapping a second plurality of second point data relative to 10
the second transducer assembly to develop a second
locus set; and

correlating the first point data to the second point data; and
generating a correlated point data.

19. The method of claim **18**, further comprising: 15
modeling the correlated point data to generate a three-
dimensioned model of the seabed.

20. The method of claim **17**, wherein:
generating the digital elevation model includes: 20
mapping the first plurality of first point data relative to
the first transducer assembly based upon a selected
temporal moment; and

18

mapping a second plurality of second point data relative
to the second transducer to develop a second locus set
based upon the temporal moment.

21. The method of claim **20**, wherein:
generating the digital elevation model includes:

selecting a temporal interval to include a substantially
continuous plurality of temporal moments.

22. The method of claim **16**, wherein the parallax image
includes:

static elements remaining substantially unchanged over
time within a temporal interval; and

dynamic elements varying over time within the temporal
interval.

23. The method of claim **22**, further comprising:
suppressing the static elements in the parallax image to
isolate dynamic elements in the parallax image.

24. The method of claim **22**, further comprising:
grouping dynamic elements into targets according to varia-
tion within the temporal interval.

* * * * *